

TFE 2, TFE 4



**AGFEO**  
einfach | perfekt | kommunizieren

## **Safety Notice**

The door phones have been designed to be connected directly to the SLT (POT) port of a telephone system. The voltage for the door phone will be supplied by the telephone system. Door locks and external bells can be operated in addition but would require a bell transformer to supply voltage to the door phone. Ensure that the voltage for the door lock will be between 8 V ~ and 14V ~ and that the switched current will not be higher than 2 A ~. The door phone has only been licensed for its intended use. AGFEO GmbH will not be liable for any damage if the door phone is used other than for its intended use.

The housing of the door phone may not be opened. Unauthorised opening of the unit and improper repair may be hazardous to users and will invalidate the warranty.

Plugs which show defects or power supply units with defect housing must not be continued to be used due to the danger of an electric shock. Ensure that such items are immediately replaced with original parts.

The door phone may only be connected to power supply units which deliver a SELV Voltage or comply to ETS 300 047. The intended use of the authorised apparatus fulfils this requirement.

DO NOT let liquids enter the inside of the door phone as there could be the danger of an electric shock or short circuiting.

DO NOT install the door phone during a thunder storm or connect or disconnect any cable connections to eliminate the danger of an electric shock.

DO NOT connect any apparatus which recalls to earth on their lines. You must not connect the a/b wire to earth as permanent damage to the unit may result.

# TFE 2, TFE 4

## Table of Contents

Safety Notice .....	2
Introduction .....	4
Supplied Items .....	5
Location of Unit .....	7
Flush Mounted Fitting .....	8
Surface Mounting .....	10
Installation der TFE .....	11
<b>Basic Settings</b>	
Telephone System Configuration .....	12
Doorphone Setup .....	13
Enter Extension Number of Bell Push .....	13
To Start Programming Mode .....	13
<b>Additional Programming</b>	
Doorphone Setup .....	14
To Start Programming Mode .....	14
Door Opener (Remove Restriction) .....	14
Set Timer for Door Opener .....	14
Ringing Duration to Extension .....	15
Set Call Duration .....	15
Select Door Phone Operation .....	15
Door Phone Calibration .....	15
Microphone Sensitivity Speaker Volume .....	16
Change PIN of Door Phone .....	16
Resetting the Door Phone to Default .....	16
Connecting Additional Door Bells .....	17
Allocation of Bell Push Buttons to Switched Output .....	17
Change Allocation .....	17
<b>Technical Data</b>	
Confirmation Tones .....	18
Declaration of Conformity for TFE 2 .....	19
Declaration of Conformity for TFE 4 .....	20
Declaration of Conformity for Power Supply .....	21

# TFE 2, TFE 4

## Introduction

The AGFEO Doorphones may be connected to the analogue extension ports of AGFEO Telephone Systems if this has been set to "Door".

Please contact your Dealer for connections to AGFEO Systems which do not support the operation mode "Door".

The AGFEO TFE 2 can be fitted with 1 or 2 bell push buttons. In addition there is a 12 V contact and a potential free relay contact.

The AGFEO TFE 4 can be fitted with 3 or 4 bell push buttons. In addition there is a 12 V contact and a potential free relay contact.

The bell push button, in which a name plate may be inserted, is illuminated. A bell transformer is required for the operation of the button illumination, voltage to the door release and the operation of the potential free contact relay.

The bell transformer is supplied as a Plug In Type Power Supply and is available optionally. (Order No. 6100259)

The door phones are optimised to work with AGFEO Telephone Systems.

# TFE 2, TFE 4

## Supplied Items

- |   |                            |
|---|----------------------------|
| 1 Door Phone incl. Cover and Assembled Bell Push Module<br>(with 2 push buttons for TFE 2 and 4 push buttons for TFE 4) | 1 Pack with 2 Wall Plugs   |
| 1 Flush Mounted Housing   | 2 Screws 4 x 30            |
| 1 Additional Bell Push Module (with 1 button for TFE 2 and 3 buttons for TFE 4)   | 2 Screw Covers             |
| 1 Surface Mounted Housing   | 1 Cable Sleeve             |
|   | 2 Allen Screws             |
|   | 4 Fixing Clamps            |
|   | 4 Screws for Fixing Clamps |
|   | 1 Allen Key                |

## Installation Instructions

The Door Phones TFE 2 and TFE 4 are suitable for surface or flush mounting. In addition the TFE 2 may be installed upright or horizontally. The bell push module can be turned by 90°.

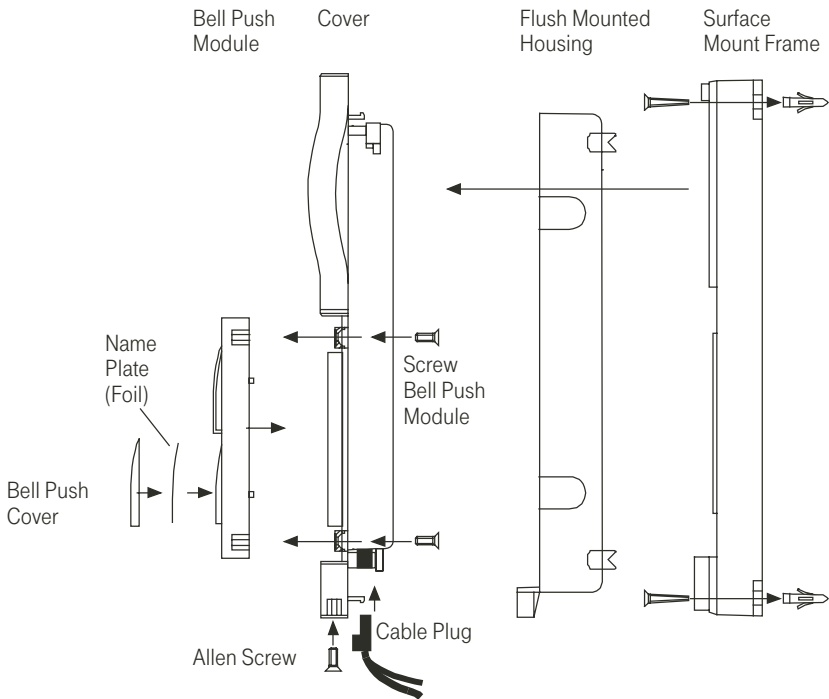

# TFE 2, TFE 4

## Installation Options

Before the installation of the door phone you may want to decide if you want to fit the module upright or horizontally. This is only applicable to the modules with one or two bell push buttons. The module with three or four buttons can only be installed upright.

**It is important to pay attention to the button numbers for programming!**

Various fitting options for the TFE 2

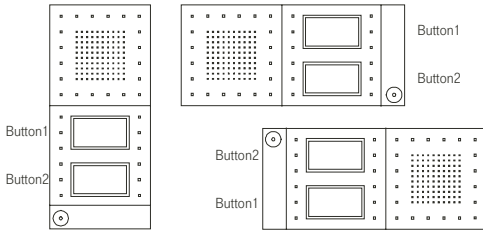

Fitting options with 1 button

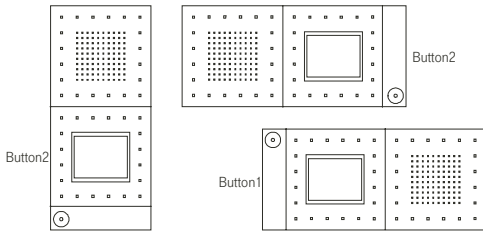

Fitting options with 3 or 4 buttons

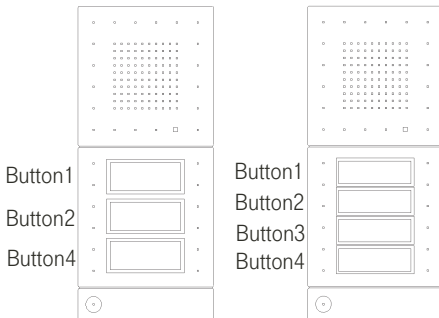

# TFE 2, TFE 4

## Location of Unit

The door phone TFE 2 and TFE 4 have been designed for use outside and are protected from water splashes (Dampness protection to IP 53, water splashes of an angle of 60° from vertically) Please select the location of the unit so that there is a minimum distance of 10 cm ( 4 inches ) from the microphone to the nearest wall. Also ensure that the selected installation location is free of other services, such as mains cable etc.

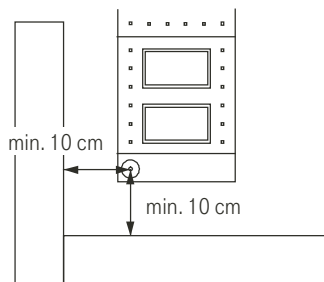

# TFE 2, TFE 4

## Flush Mounted Fitting

The wall cut out should fit the measurements of the flush mounted housing. (Observe minimum distance and location of installation) Please make sure that there are no mains services buried in the wall. Measurements for the cut out to be L x H x D approx. 220 x 90 x 50 mm.

### Cable Entry

A cable entry slot is available on all sides of the flush mounted housing. The cable entry locations are pre assigned and can be broken out.

### Fixing of Flush Mounted Housing

The housing can be fixed with additional fixing clamps and screws at the four pre assigned points of the housing. The housing must be flush to the wall as otherwise the cover cannot be fixed. If the wall is going to be plastered at later time, then the thickness of the plaster must be observed.

### Connection of Door Phone to System

Connect the wires to the supplied clip and connect this to the printed circuit board. (see Door Phone Installation)

### Inserting the Door Phone

Hook the door phone into the top of the housing and at the same time pressing the unit upwards to the wall until this snaps into place. Afterwards tighten the two screws with the Allen Key provided.

### Door Phone Calibration and Configuration

Now carry out the calibration, configuration and commissioning. (see Chapters: Tuning and configuration, also TFE commissioning)

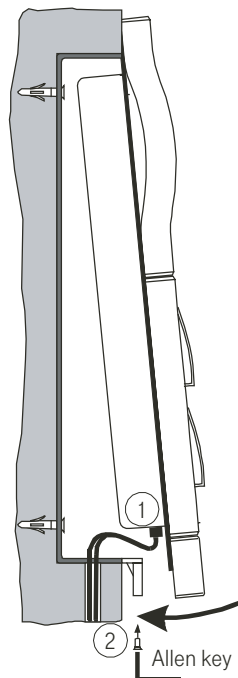



# TFE 2, TFE 4

## Remove Door Phone from Flush Mounted Housing

Unscrew both screws with the Allen Key provided from underneath the cover.

### Remove Door Phone from Flush Mounted Housing

To release the unit use a medium sized screw driver or Allen Key and press the bottom latch then pull off the door phone with an upward movement.

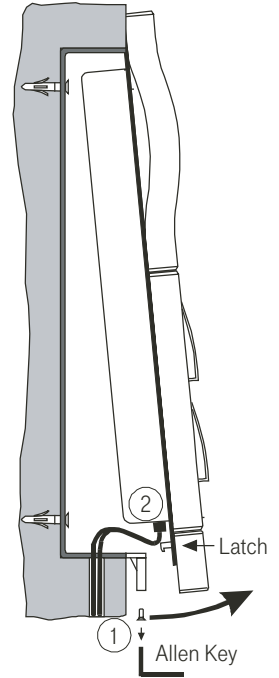

# TFE 2, TFE 4

## Surface Mounting

Fit the surface housing either upright or horizontally as required. (Observe minimum distance) Before drilling ensure that there are no life wires or other main services. Fix the housing using the wall plugs supplied and screw this to the wall

### Connection of Door Phone to System

Install cable to the telephone system and door opener. Drill a 9mm hole in the surface frame were required, pull the cable through the sleeve and connect the wires to the supplied clip then connect this to the printed circuit board. (see Door Phone Installation)

### Insert Door Phone

Hold door phone over the fixing hooks of the surface mount housing and then press firmly until you hear it click into place. Tighten both screws with the Allen Key provided.

### Door Phone Calibration and Configuration

Now carry out the calibration, configuration and commissioning. (see Chapters: Tuning and configuration, also TFE commissioning)

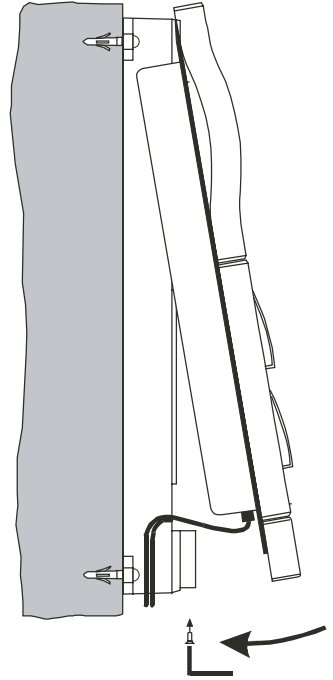

## Deinstallation

Loosen the door phone by unscrewing the two Allen Screws underneath the unit using the Allen Key provided.

Remove Door Phone from its housing.

To release the unit use a medium sized screw driver or Allen Key and press the bottom latch then pull off the door phone with an upward movement.

# TFE 2, TFE 4

## Name Plate

Remove the cover of the name plate by using a medium size screw driver inserting this into the cut out on either the left or right hand side and carefully moving this upwards.

Write on the name plate using a waterproof pen and insert the label in the recess of the bell push. Afterward refit the name plate cover by aligning this over the bell push and pressing it into place.

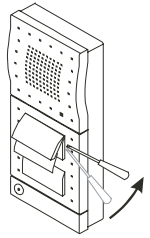

## Installation der TFE

Please use standard telephone cable for the wiring of the doorphone. The maximum distances between telephone system and door phone / opener are listed in the table below:

Cable Diameter	0,6 mm	0,4 mm
Distance for Speech and Signalling	120 m	80 m
Distance for Door Opener Operation (12V) from external Bell Transformer to Door Opener	38 m	17 m

Do not install cables parallel to mains cable. Should the cable be installed underground, then please ensure that you will use an armoured telephone cable or a waterproof trunking. The telephone system and the bell transformer must be unplugged from the mains power before you connect the doorphone to the telephone system.

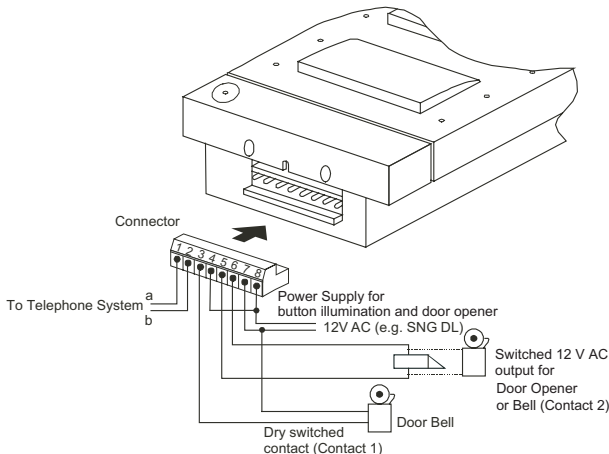

# TFE 2, TFE 4

## Basic Settings Telephone System Configuration

The following will describe the basic configuration for AGFEO Telephone System „AS“ Series and the AGFEO AC 14 Analogue. After connection of the doorphone to your telephone system download the configurator of your telephone system. Allocate an extension number to the port to which the doorphone is connected and set the type of device to „Door“ in the section „System Phones, Analogue Devices“. Note that the doorphone will have to seize an outside line with the digit „9“ (or „0“)

Port	Ext. No.	Phone Type
Port 1	60	Door

Click onto „Door“ in the section „Devices:Door“ and „2 wire a/b“. Allocate to each bell push an extension number and make a selection in the call distribution.

Door bell	Ext. No.	Phone Type
Door bell 1	Bell Push 1 (61)	Bell Push 1 (61)
Door bell 2	Bell Push 2 (62)	Bell Push 2 (62)
Door bell 3	-	-
Door bell 4	-	-

**Door settings**

Duration of Door Phone Call	30 secs.
Force Release Door Phone (secs.)	600 secs.

**DTMF digits for 2-Wire a/b Door Interfaces**

DTMF Digits for Speaking Mode	1
DTMF Digits for Opening	#9
DTMF Digits for Disconnect	#0

Enter for how long a door call should be signalled for and the time an external call is allowed to stay connected before this will be force released. Please ensure that the max. calling time set in the door phone will always be lower then that of the setting in the telephone system. Otherwise you may hear busy in the speaker of the doorphone for the remaining seconds if the call is directed from the telephone system to the doorphone.

Finally enter the DTMF signalling for the following: „#9“ to operate the lock release, „#0“ to end a door call and any number to speak. Send the data into the telephone system.

# TFE 2, TFE 4

## Doorphone Setup

In order to make changes to the door phone setting, the door phone extension must be called from a DTMF telephone. Programming can begin as soon as a connection has been established to the door phone. **Please ensure to enter digits without any delay in between them** as otherwise the door phone may reject the entry as incorrect!



You may find it helpful to write down the dialling sequence prior to programming. Should the programming be rejected from the doorphone (ie. negativ confirmation tone) then programming must be re-entered.

## To Start Programming Mode

						
Lift Receiver	Dial Door Extension	positive Tone	Start Prgm Mode	Neutral Tone	Enter-PIN (0000 default)	positive Tone

NOTE. Programming mode will end as soon as the receiver is replaced!

## Enter Extension Number of Bell Push

Enter Programming Mode:      

 	 1..4				
Select Bell Push from 1 to 4	Confirm entry with „1“	Neutral Tone	Enter the extension number as allocated in TK-Suite	After approx. 20 sec. positive confirmation tone	

This programming may be carried out consecutively after programming mode has been initiated. The allocation of bell push buttons can be found on page 6.

As soon as extension numbers have been programmed the AGFEO TFE2/TFE4 is operational. The following pages will illustrate further programming possibilities.

# TFE 2, TFE 4

## Additional Programming Doorphone Setup

In order to make changes to the door phone setting, the door phone extension must be called from a DTMF telephone. Programming can begin as soon as a connection has been established to the door phone. **Please ensure to enter the digits without any delay in between digits** as otherwise the door phone may reject the entry as incorrect!

You may find it helpful to write down the dialling sequence prior to programming. Should the programming be rejected from the doorphone (ie. negativ confirmation tone) then programming must be re-entered.

## To Start Programming Mode

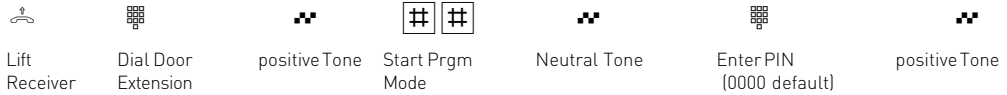

NOTE. Programming mode will end as soon as the receiver is replaced!

## Door Opener (Remove Restriction)

For security reasons the door opener cannot be operated (unauthorised opening) when the call is made from the telephone to the doorphone. You may, if you wish remove this restriction.

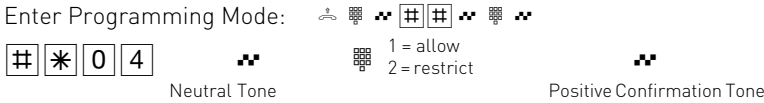

## Set Timer for Door Opener



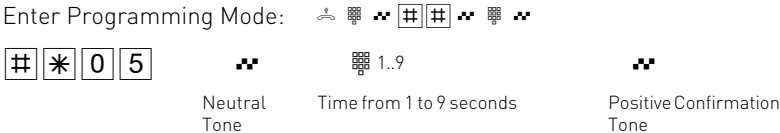





You can set the timing for the door opener between 1 and 9 seconds. In default the time is set to 3 seconds.







# TFE 2, TFE 4

## Ringing Duration to Extension

The time the door phone is able to ring an extension can be set between 1 and 99 seconds. In default the time is set to 30 seconds.

Enter Programming Mode:        









  
Neutral  
Tone





 01..99  
Time from 01 to 99 seconds

  
Positive Confirmation  
Tone

## Set Call Duration

The call duration can be set between 1 and 9 minutes. In default the unit is set to 1 minute.

Enter Programming Mode:        

  
Neutral  
Tone

 1..9  
Time from 1 to 9 minutes

  
Positive  
Confirmation Tone

## Select Door Phone Operation

With this setting you can select if the speech path to the door phone is automatically being established after answering the call, or only after a digit has been pressed. The default setting is answer the door phone after a digit has been pressed.

NOTE: If you have selected automatic connection then you may leave the field blank in TK -Suite "Digit for Speaking".

Enter Programming Mode:        





  

 1= automatic  
0= after pressing digit  
select option





  
Positive  
Confirmation Tone

## Door Phone Calibration

In order to guarantee an optimal speech quality with AGFEO Telephone Systems the door phone TFE2 and TFE4 can automatically adjust to the relevant telephone system used .

With the Procedure     the calibration process will be started. A test tone will be played during which the Talk LED will blink intermittently. This calibration will take approx. 20 seconds. During this time you should not speak into the telephone receiver as this may interfere with the automatic adjustment.

Enter Programming Mode:        







   

  
positive confirmation tone after 20 seconds

# TFE 2, TFE 4

## Microphone Sensitivity Speaker Volume

You may adjust the microphone sensitivity and speaker volume. The sensitivity of the microphone can be set in a range 4 steps, the speaker has a setting range of 32 steps.

Enter Programming Mode:       







Press the digit **[2]** to decrease the microphone sensitivity by one step. You will hear a positive confirmation tone if the minimum setting has been reached.

Press the digit **[3]** to increase the microphone sensitivity by one step. You will hear a positive confirmation tone if the maximum setting has been reached.

Press the digit **[5]** to decrease the speaker volume by one step. On reaching the minimum level a positive confirmation tone will be returned.

Press the digit **[6]** to increase the speaker volume by one step. On reaching the maximum level a positive confirmation tone will be returned.

## Change PIN of Door Phone

Enter Programming Mode:       

**[#] [\*] 8 8**

Neutral Tone

 Enter a new 4 digit PIN







Neutral Tone

 Confirm the new 4 digit PIN

Positive Confirmation Tone

## Resetting the Door Phone to Default

The unit may be reset to the preset default setting.

Enter Programming Mode:       

**[#] [\*] 9 9**

Special confirmation Tone



# TFE 2, TFE 4

## Connecting Additional Door Bells

You may connect an additional doorbells to each of the dry switched contact or the 12 V output of the doorphone. To connect a door bell to the dry switched contact you must feed a supply voltage to the doorphone and the door bell. With reference to the activation of the door bell, please note that the relays are switched only for the duration of pressing the bell push button.

## Allocation of Bell Push Buttons to Switched Output

You have up to 16 possibilities of programming the allocation of bell push buttons. The following table will indicate which switching command has to be used in order to achieve the required setting. For example if pressing bell push 2 should activate the switching command 1, the the following program is to be entered:

# \* 6 1 0 2



Button 1	Button 2	Button 3	Button 4	Switching Command
				00
Bell				01
	Bell			02
Bell	Bell			03
		Bell		04
Bell		Bell		05
	Bell	Bell		06
Bell	Bell	Bell		07
			Bell	08
Bell			Bell	09
	Bell		Bell	10
Bell	Bell		Bell	11
		Bell	Bell	12
Bell		Bell	Bell	13
	Bell	Bell	Bell	14
Bell	Bell	Bell	Bell	15

## Change Allocation

Enter Programming Mode:     # #   

# \* 6

 1 =Contact 1  
2 =Contact 2

 Switching Command 00 to 16 

Select the contact for which you want to change the allocation.

Select the required allocation using the table above.

Positive Confirmation Tone

# TFE 2, TFE 4

## Technical Data

Operating Temperature Range:	-25 C° bis +55 C°
Storing Temperature:	-25 C° bis +70 C°
Transport Temperature:	-25 C° bis +70 C°
Door Phone Cover:	104 x 234 x 17 mm
Surface Mount Frame:	100,3 x 230,3 x 28 mm
Flush Mounted Housing:	79,2 x 206 x 41,9 mm
Load of Potential Free Contact:	12V, 1A
Load of 12 V Output:	12V, 1A
Weight:	486 g
Dampness Protection:	IP 53

## Confirmation Tones

### Neutral Confirmation Tone

An Entry is Expected



### Positive Confirmation Tone

The Program Command has been successful



### Negative Confirmation Tone

Error in Programming, Entry No Set



## Declaration of Conformity for TFE 2

### EU-Konformitätserklärung

EC-Declaration of Conformity  
CE-Déclaration de Conformité

**Der Hersteller:** AGFEO GmbH & Co. KG

The Manufacturer:  
Le Constructeur:

**Adresse:** Gaswerkstr. 8  
D - 33647 Bielefeld

Address:  
Adresse:

**Erklärt, dass das Produkt:** TFE 2

Declares that the Product:  
Déclare que le Produit:

**Type:** Türfreisprecheinrichtung

**Model:** TFE 2

**Components:**

**die grundlegenden Anforderungen gemäß Artikel 3 der nachstehenden EU-Richtlinien erfüllt:**

meets the essential requirements according to article 3 of the following EC-Directive:  
est conforme aux exigences essentielles d' article 3 de la Directive CE.

**Richtlinie 1999/5/EG des Europäischen Parlaments und des Rates vom 09. März 1999  
über Funkanlagen und Telekommunikationsendeinrichtungen und die gegenseitige  
Anerkennung ihrer Konformität**

Directive 1999/5/EC of the European Parliament and of the Council of 09 March 1999 relating to radio and telecommunications terminal equipment, including the mutual recognition of their conformity  
Directive 1999/5/CE du Parlement européen et du Conseil du 09 mars 1999 concernant les radio et équipement terminaux de télécommunications, incluant la reconnaissance mutuelle de leur conformité

**und dass die folgenden harmonisierten Normen angewandt wurden:**

and that the following harmonised standards has been applied:  
et que les standards harmonisés suivants ont été appliqués:

EN 55022/2003  
EN 55024/2003  
EN 60950/2001

Bielefeld, 13. Mai 2005

**Ort und Datum der Konformitätserklärung**  
Place and date of the declaration Lieu et date de la déclaration

Phone : +49(0)5 21 44 70 9-0  
FAX : +49(0)5 21 44 70 9-50



**Name und Unterschrift**  
Name and Signature Nom et Signature

## Declaration of Conformity for TFE 4

### EU-Konformitätserklärung

EC-Declaration of Conformity  
CE-Déclaration de Conformité

**Der Hersteller:** AGFEO GmbH & Co. KG

The Manufacturer:  
Le Constructeur:

**Adresse:** Gaswerkstr. 8  
D - 33647 Bielefeld

Address:  
Adresse:

**Erklärt, dass das Produkt:** TFE 4

Declares that the Product:  
Déclare que le Produit:

**Type:** Türfreisprecheinrichtung

**Model:** TFE 4

**Components:**

#### die grundlegenden Anforderungen gemäß Artikel 3 der nachstehenden EU-Richtlinien erfüllt:

meets the essential requirements according to article 3 of the following EC-Directive:  
est conforme aux exigences essentielles d' article 3 de la Directive CE:

#### **Richtlinie 1999/5/EG des Europäischen Parlaments und des Rates vom 09. März 1999 über Funkanlagen und Telekommunikationsendinrichtungen und die gegenseitige Anerkennung ihrer Konformität**

Directive 1999/5/EC of the European Parliament and of the Council of 09 March 1999 relating to radio and telecommunications terminal equipment, including the mutual recognition of their conformity  
Directive 1999/5/CE du Parlement européen et du Conseil du 09 mars 1999 concernant les radio et équipement terminaux de télécommunications, incluant la reconnaissance mutuelle de leur conformité

#### und dass die folgenden harmonisierten Normen angewandt wurden:

and that the following harmonised standards has been applied:  
et que les standards harmonisés suivants ont été appliqués:

EN 55022/2003  
EN 55024/2003  
EN 60950/2001

Bielefeld, 13. Mai 2005

**Ort und Datum der Konformitätserklärung**  
Place and date of the declaration Lieu et date de la déclaration

Phone : +49(0)5 21 44 70 9-0  
FAX : +49(0)5 21 44 70 9-50

  
**Name und Unterschrift**  
Name and Signature Nom et Signature

### EU-Konformitätserklärung

EC-Declaration of Conformity  
CE-Déclaration de Conformité

**Der Hersteller:** AGFEO GmbH & Co. KG

The Manufacturer:  
Le Constructeur:

**Adresse:** Gaswerkstr. 8  
D - 33647 Bielefeld

Address:  
Adresse:

**Erklärt, dass das Produkt:** Steckernetzteil TFE 2/ TFE 4

Declares that the Product:  
Déclare que le Produit:

**Type:** Steckernetzteil TFE 2/ TFE 4

**Model:** Steckernetzteil TFE 2/ TFE 4

**Components:**

#### die grundlegenden Anforderungen gemäß Artikel 3 der nachstehenden EU-Richtlinien erfüllt:

meets the essential requirements according to article 3 of the following EC-Directive:  
est conforme aux exigences essentielles d' article 3 de la Directive CE:

#### Richtlinie 1999/5/EG des Europäischen Parlaments und des Rates vom 09. März 1999 über Funkanlagen und Telekommunikationsendeinrichtungen und die gegenseitige Anerkennung ihrer Konformität

Directive 1999/5/EC of the European Parliament and of the Council of 09 March 1999 relating to radio and telecommunications terminal equipment, including the mutual recognition of their conformity  
Directive 1999/5/CE du Parlement européen et du Conseil du 09 mars 1999 concernant les radio et équipement terminaux de télécommunications, incluant la reconnaissance mutuelle de leur conformité

#### und dass die folgenden harmonisierten Normen angewandt wurden:

and that the following harmonised standards has been applied:  
et que les standards harmonisés suivants ont été appliqués:

EN 55022/2003  
EN 55024/2003  
EN 60950/2001

Bielefeld, 6. Juni 2005

#### Ort und Datum der Konformitätserklärung

Place and date of the declaration Lieu et date de la déclaration

Phone : +49(0)5 21 44 70 9-0  
FAX : +49(0)5 21 44 70 9-50



**Name und Unterschrift**  
Name and Signature Nom et Signature







The crossed out wheeled bin on the product means that this belongs to the group of Electro- and electronic apparatus.

In this context you are directed by the European regulation to dispose of used apparatus  
- at the point of buying an item of equal proportion / value  
- at the local available collection point for disposal

With this you will participate in the reuse of material and valorisation of disused electric- and electronic apparatus, which otherwise could be a health hazard and be negative to the environment.



Ident. no. 1100925

Subject to change without notice. No liability can be accepted for errors contained in this document.

Printed in Germany

0091

AGFEO GmbH & Co. KG

Gaswerkstr. 8

D-33647 Bielefeld

Internet: <http://www.agfeo.com>